

Round Operators - Push-Buttons

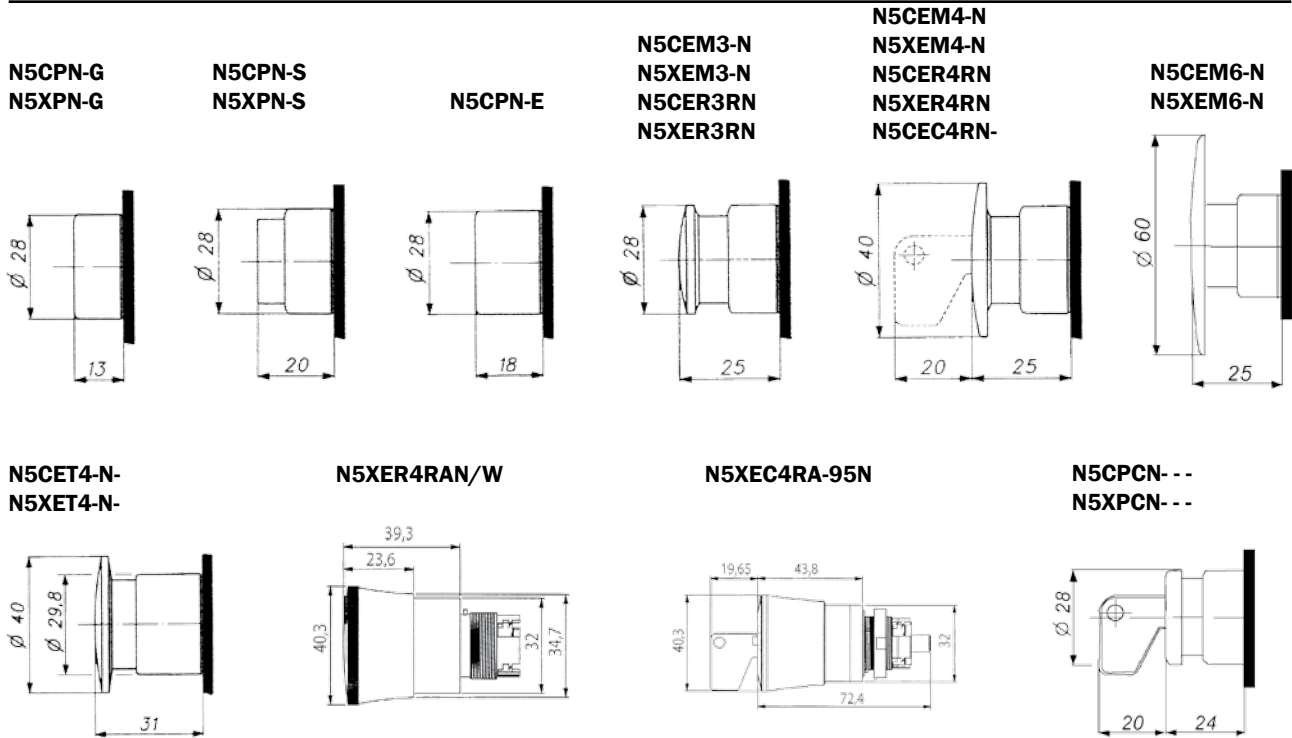

Round Operators - Selector Switches

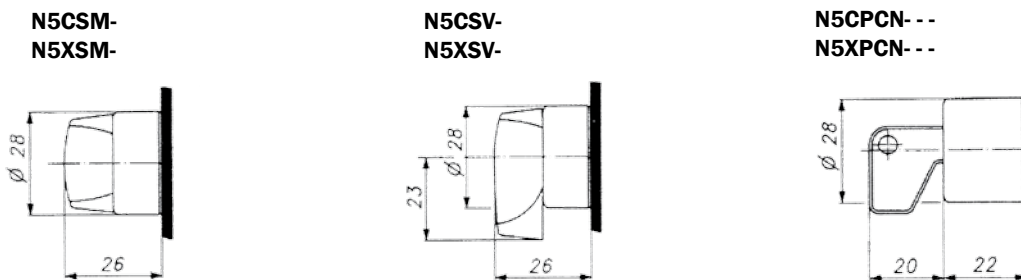

Round Operators - Illuminated Push-Buttons and Selector Switches

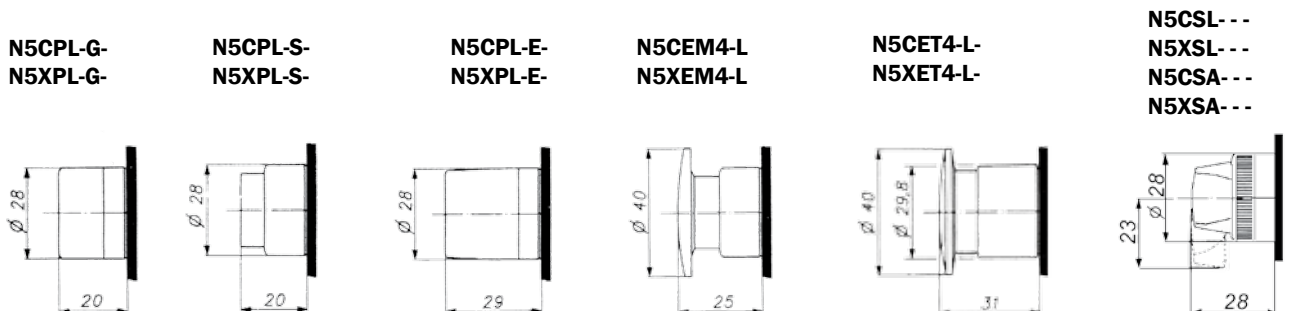

DIMENSIONS

Round Operators - Pilot Lights

**N5CL--
N5XL--**

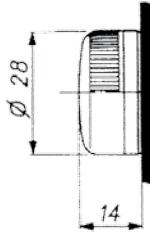

N5CL-V

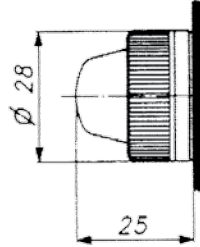

N5XU--

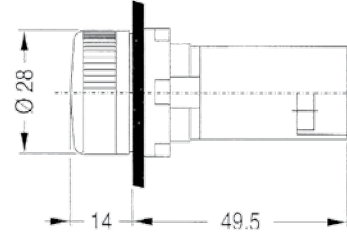

Round Operators - Other Devices

N5XC-

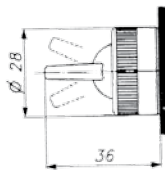

**N5CMN-
N5XMN--**

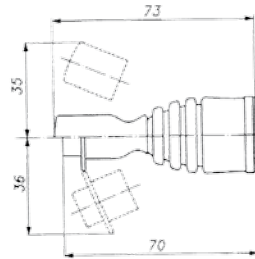

N5XMB--

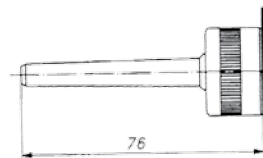

**N5CRG
N5XRG**

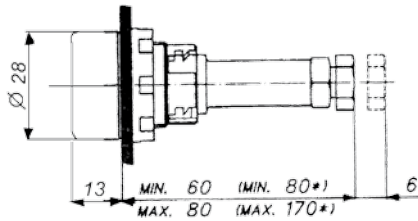

*with accessory N5ACVLR

**N5CZ
N5XZ**

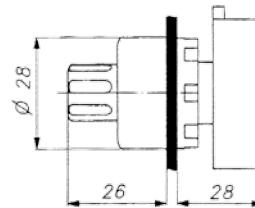

Square Operators - Double Function Push-Buttons

N5DPL-- G --

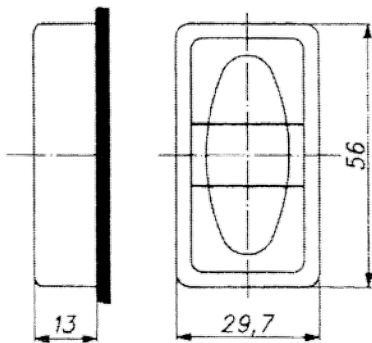

N5DPL-- S --

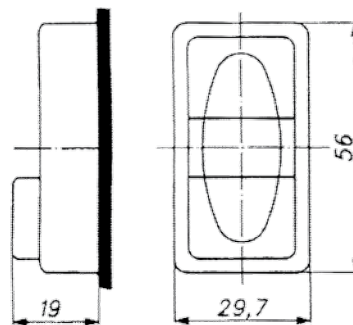

Square Operators - Other Devices

**Adaptor
N5ARSN1**

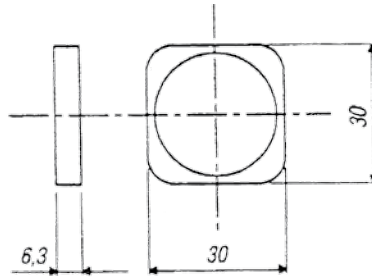

Contact Blocks

N5B01V- /

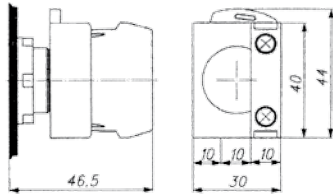

N5B01FN /

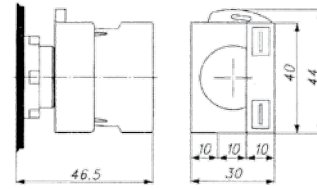

**N5B011VN
N5B02VN
N5B20VN**

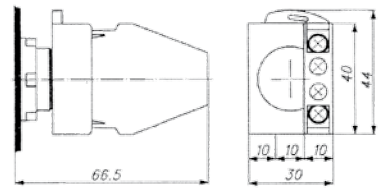

G31

Power Supplies

**N5PDNV0
N5PRLV -
N5PRDV-**

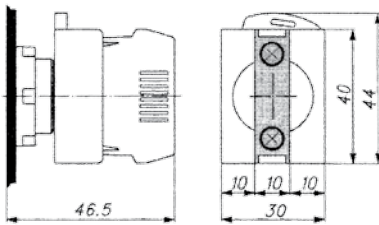

N5PDNF0

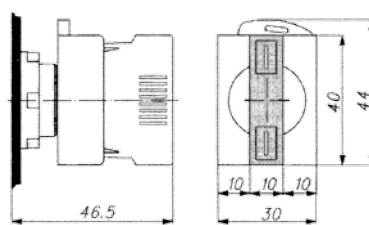

**N5PRNV-
N5PDTV0
N5PRTV-**

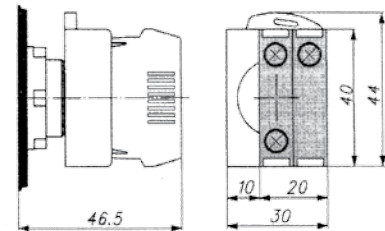

N5PREV-

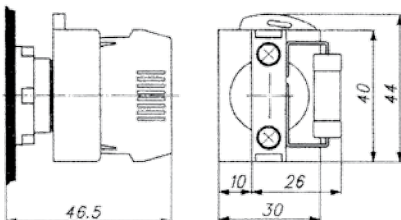

N5PTNV-

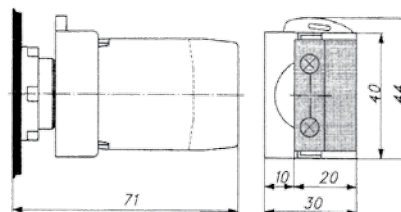

N5PDMV- /

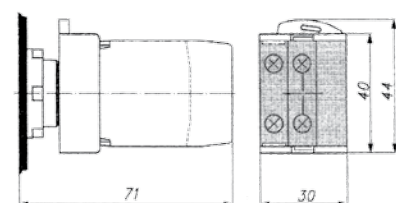

DIMENSIONS

Push-On / Push-Off Devices

N5ACDPP

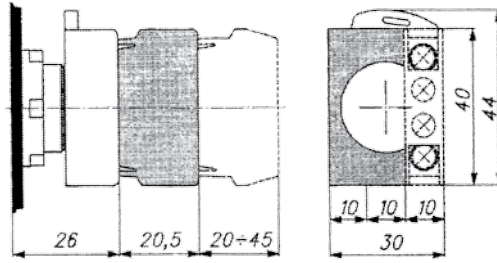

Protection Cover

N5ACRCL

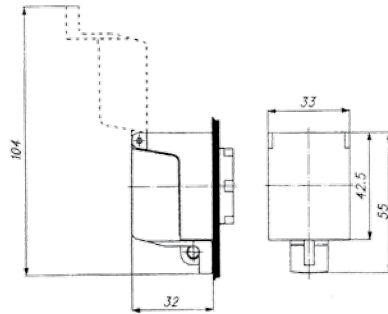

Insert Holders and Plates

N5ARTBS

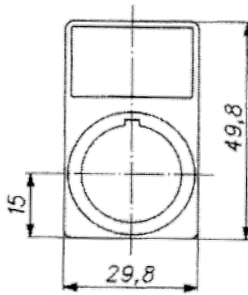

N5ARTBM

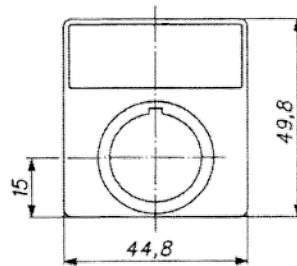

N5ASTBS

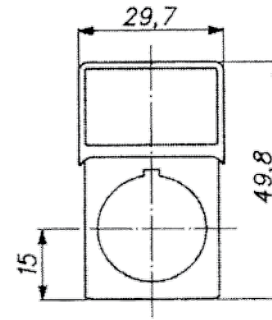

Contact Blocks

**N5B01BN
N5B10BN**

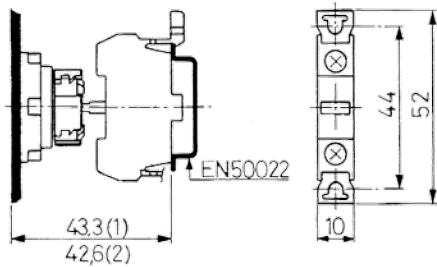

(1) With insert holder
(2) Without insert holder

Power Supplies

N5PDNB0

